

CRANE MASTER SERIES

LED INDUSTRIAL LIGHTING FOR HARSH AREAS

FLOOD



Reliable. Durable. Efficient.
20,000 to 80,000 lumen models

RED SKY
SERIOUSLY SAFE LIGHTS™

ABOUT RED SKY LIGHTING

PIONEERING INDUSTRIAL ILLUMINATION FOR HARSH & HAZARDOUS CONDITIONS

A leading manufacturer of premium LED lights for demanding work conditions

Headquartered in California, products assembled in the USA

Servicing global clients across 4 continents in metal processing, oil & gas, marine, manufacturing

Renowned for quality, dependability, client care and uncompromising safety standards

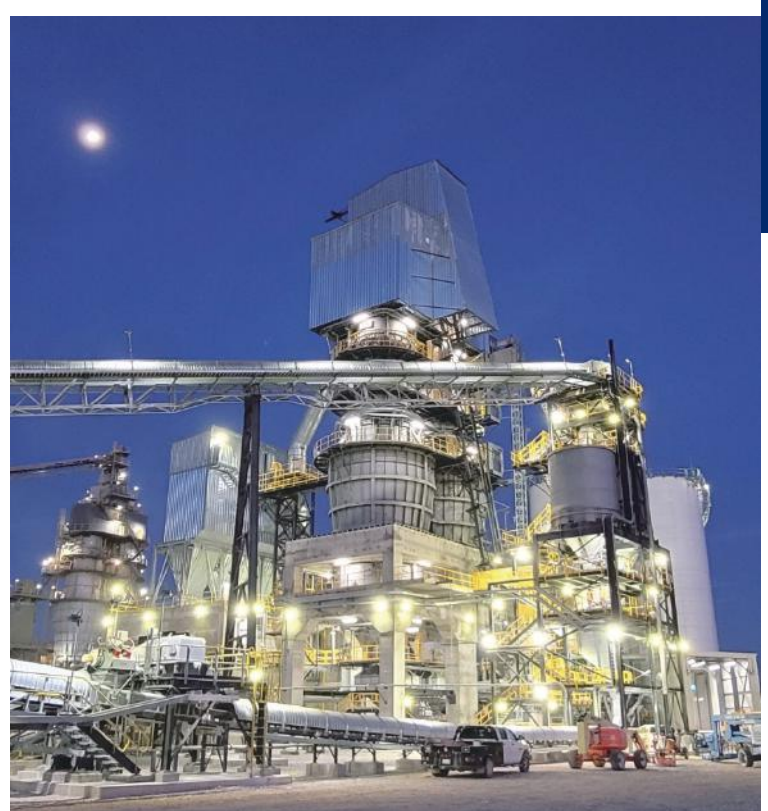

WHY CHOOSE RED SKY

❧ SERIOUSLY SAFE LIGHTS

- Rigorously tested in our professional labs
- Surpassing industry certifications and safety protocols
- Crafted with highest grade components for maximum durability

❧ TOP-NOTCH SERVICES

- Team of experts for seamless support
- Energy audit services, lighting simulation services
- Hassle-free return policy and management

❧ FAST DELIVERY

- Majority of orders delivered within 14 days
- Same day shipping for products in stock
- Real-time order tracking for full transparency



❧ SUSTAINABLE SOLUTIONS

- High luminous efficacy LEDs for energy savings
- Conscious product design
- Recyclable materials for products and packaging

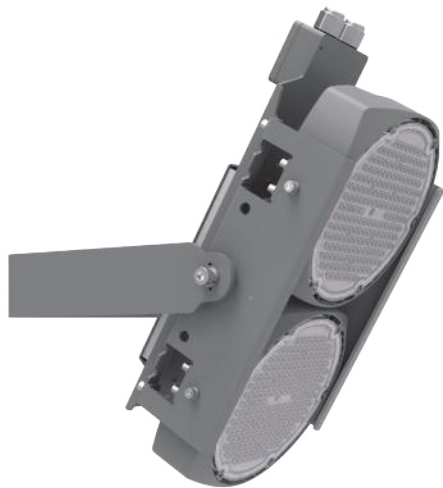

FEATURES



-  **5 Choices of Light Distributions**
30° / 60° / 90° / 120° / 30*120°
available for different applications from narrow to assymetric light distribution
-  **Easy and Through Wiring**
Built-in wiring compartment with two cable entries and WAGO 221 lever connectors for easy wiring (1~4mm²)
-  **The damper bracket is rotatable and ensures light is constantly targeted where required**

RATINGS

IP67
IK08
IEC60068-2-6 5g
Salt Spray 720 hrs (ISO 9227)

CERTIFICATIONS

UKCA
ROHS
CE LVD/EMC

TECHNICAL PARAMETERS

Specification	CMF-150	CMF-300	CMF-420	CMF-560
Electrical Parameters				
Power	150W	300W	420W	560W
Rated Input Current (220V AC)	0.758A	1.516A	2.122A	2.829A
Voltage/Frequency	100-240V AC 50/60Hz			
Power Factor	≥0.90			
THD	<20%			
L70	130,000 hrs@50°C			
Surge Protection	L/N-FG 6KV, L-N 4KV			
Supply Wire	1mm ² -4mm ² , Rated 90°C			
Warranty	5 Years			
Optical Parameters				
Lumen Output*	20,439Lm	42,425Lm	58,852Lm	79,230Lm
Lumen Efficacy*	140Lm/W			
Available Beam Angle	30°/60°/90°/30*120°(PC)/120°(Glass)			
Correlated Color Temperature (CCT)	4000K/5700K			
Color Rendering Index (CRI)	Ra>70			
Mechanical Parameters				
Housing Material	Marine Grade Aluminium			
Hardware	Stainless steel 316			
Lens Material	Tempered Glass or Polycarbonate			
Mounting Options	Yoke			
Product Weight	16.5lbs/7.5kg	30.9lbs/14kg	39.7lbs/18kg	50.7lbs/23kg
Package Weight	18.6lbs/8.5kg	34lbs/15kg	41.8lbs/19kg	52.8lbs/24kg
Cable Entry	(2) M20			
Product Dimensions(L×W×H)	10.2x9.1x5.8in (260x230x148mm)	22x11x6.7in (559x280x171mm)	24.9x11x6.7in (632x280x171mm)	19.2x16.5x6.7in (487x420x171mm)
Package Dimensions(L×W×H)	23.1x15.2x9.4in (586x386x238mm)	24x23.4x9.4in (610x594x238mm)	29.3x13.7x9.4in (743x348x239mm)	30.4x23.4x9.5in (771x600x240mm)
Environmental Parameters				
Vibration Resistance	IEC60068-2-6 5g			
Ambient Operating Temperature	-40°C~+50°C			
Optimal Operating Temperature	25°C			
EPA wind rating (FT2/m2)	1.281/0.119	1.733/0.161	2.346/0.218	3.450/0.321

* Value calculated based on 5700K and clear glass ,varies to different spec.

ORDERING INFORMATION

EXAMPLE: CMF-300-100-240-57K-90-CG-GRY-YKE

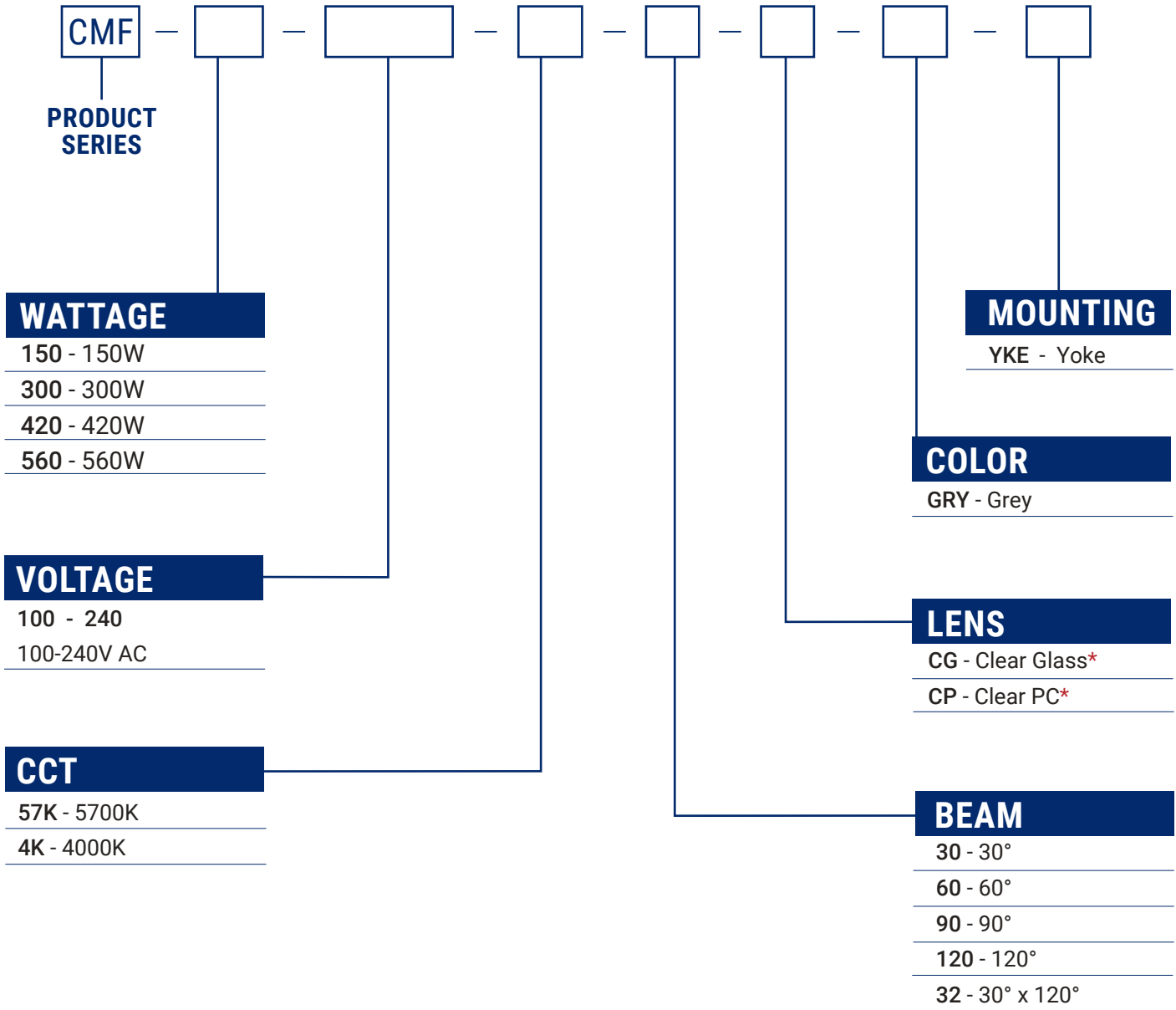

* CG: 120°
 CP: 30°, 60°, 90°, 30° x 120

OTHER ACCESSORIES



SC05



DPY01

Part Number	Description	MPN Code
SC05	Safety Cable Kit, CMF SERIES, SUS304	106060018
DPY01	Crane Damper Bracket, SUS304, Fixed with M10 bolts	309050274

REPLACEMENT PARTS (ORDERED SEPARATELY)

Part Number	Description	MPN Code
CMF-150-Driver	Replacement Driver Kit for CMF-150 Fixtures	303010085
CMF-300-Driver	Replacement Driver Kit for CMF-300 Fixtures	303010086
CMF-420-Driver	Replacement Driver Kit for CMF-420 Fixtures	303010087
CMF-560-Driver	Replacement Driver Kit for CMF-560 Fixtures	303010088
CG008-A-01	Replacement Clear Glass Lens for CMF 120 degrees	303030019
PC008-A-01	Replacement PC Lens for CMF 30 degrees	303030020
PC008-B-01	Replacement PC Lens for CMF 60 degrees	303030021
PC008-C-01	Replacement PC Lens for CMF 90 degrees	303030022
PC008-D-01	Replacement PC Lens for CMF 30 x 120 degrees	303030023

LUMEN TABLE

Part Number	Wattage (W)	CCT	Beam	Lens	Lumen Output (Lm)	Efficiency (Lm/W)
Voltage 100-240VAC						
CMF-150-100-240-57K-120-CG-GRY-YKE	150	5700K	120°	Clear Glass	20,439	146
CMF-150-100-240-57K-90-CP-GRY-YKE	150	5700K	90°	Clear PC	19,108	136
CMF-150-100-240-57K-60-CP-GRY-YKE	150	5700K	60°	Clear PC	19,410	138
CMF-150-100-240-57K-30-CP-GRY-YKE	150	5700K	30°	Clear PC	18,249	130
CMF-150-100-240-57K-32-CP-GRY-YKE	150	5700K	30°x120°	Clear PC	18,562	132
CMF-300-100-240-57K-120-CG-GRY-YKE	300	5700K	120°	Clear Glass	42,425	151
CMF-300-100-240-57K-90-CP-GRY-YKE	300	5700K	90°	Clear PC	40,071	142
CMF-300-100-240-57K-60-CP-GRY-YKE	300	5700K	60°	Clear PC	39,449	140
CMF-300-100-240-57K-30-CP-GRY-YKE	300	5700K	30°	Clear PC	36,491	129
CMF-300-100-240-57K-32-CP-GRY-YKE	300	5700K	30°x120°	Clear PC	40,574	144
CMF-420-100-240-57K-120-CG-GRY-YKE	420	5700K	120°	Clear Glass	58,852	143
CMF-420-100-240-57K-90-CP-GRY-YKE	420	5700K	90°	Clear PC	56,477	137
CMF-420-100-240-57K-60-CP-GRY-YKE	420	5700K	60°	Clear PC	54,459	132
CMF-420-100-240-57K-30-CP-GRY-YKE	420	5700K	30°	Clear PC	52,166	126
CMF-420-100-240-57K-32-CP-GRY-YKE	420	5700K	30°x120°	Clear PC	55,377	134
CMF-560-100-240-57K-120-CG-GRY-YKE	560	5700K	120°	Clear Glass	79,230	145
CMF-560-100-240-57K-90-CP-GRY-YKE	560	5700K	90°	Clear PC	75,361	137
CMF-560-100-240-57K-60-CP-GRY-YKE	560	5700K	60°	Clear PC	73,028	133
CMF-560-100-240-57K-30-CP-GRY-YKE	560	5700K	30°	Clear PC	69,638	127
CMF-560-100-240-57K-32-CP-GRY-YKE	560	5700K	30°x120°	Clear PC	72,627	132

For additional information, please contact your sales representative.

A DIRECT RETROFIT FROM HID TO LED

The CMF series LED is easy to retrofit in the same configuration as your existing HID luminaires. For example, a 300-watt Crane Master (CMF-300) delivers virtually the same illumination as its equivalent 1000 watt MH luminaire while providing 70% reduction in energy costs and up to 140,000 hours of continuous operation.







MODELS	Lumen Output (Lm)	MH Equivalent (W)	HPS Equivalent (W)
CMF-150	20,439	450	400
CMF-300	42,425	1000	750
CMF-420	58,852	1500	1000
CMF-560	79,230	1800	N.A

THE RIGHT BEAM PATTERN FOR YOUR APPLICATION

RSL optic package is engineered to deliver maximum footcandles efficiently where you need them, without wasted light or overspill.

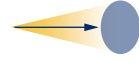
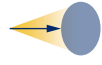
RSL offers complimentary lighting design services for our products using industry-leading AGI32 software, tailored for projects of all sizes in harsh and hazardous locations. We assist you in determining the number of fixtures needed, the types of lights to use, their optimal placement, and how to maximize energy savings—all within budget.

Simply fill out the form (<https://dev.redskylighting.com/lighting-design>) with a few key details, request a layout, and we'll bring your ideas to life within 2-5 business days.

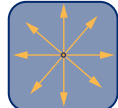
Beam	NEMA/IESNA Type	Beam Description	Beam Projection Distance
30°	NEMA 3	Medium Narrow	
60°	NEMA 4	Medium	
90°	NEMA 5	Medium Wide	
120°	NEMA 6	Wide	
T1	Type I	Asymmetric distributions, well suited for narrow areas, such as Conveyor belts, Aisleways, Catwalks, Loading docks and Tunnels.	
T2	Type II	Asymmetric distributions, well suited for narrow areas, such as roadways, paths and driveways.	
T3	Type III	Asymmetric distributions, well suited for site / area perimeters, wide roadways, and open areas.	
T5	NEMA 7 Type V (Square)	Very Wide: symmetrical pattern with excellent uniformity for large, open areas.	

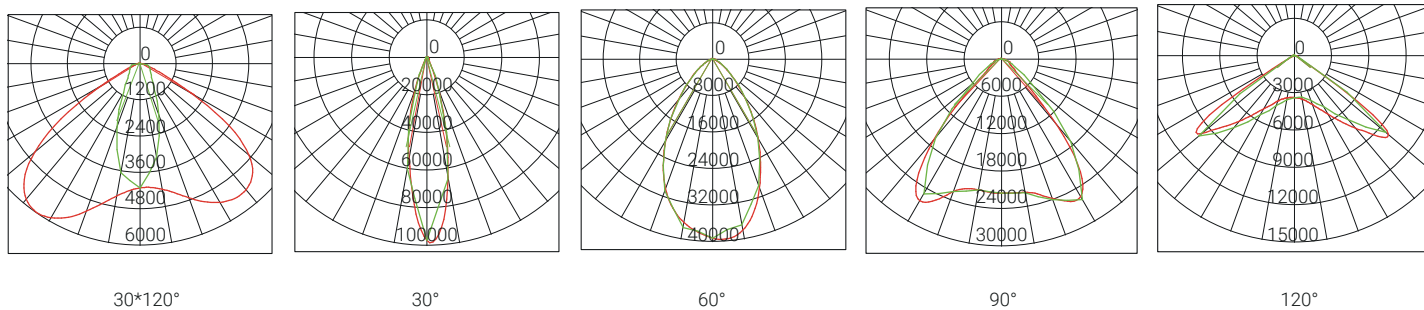

DIMENSIONS

unit: in(mm)

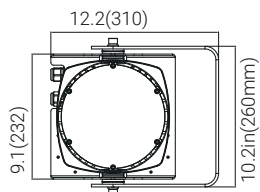

150W

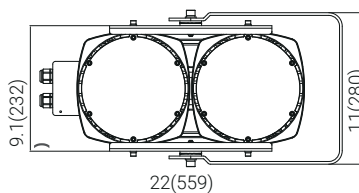

300W

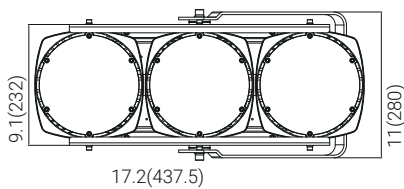
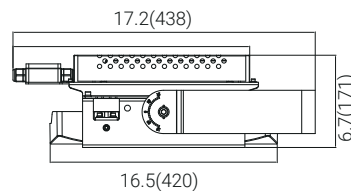
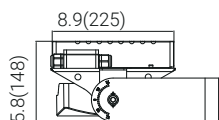

420W

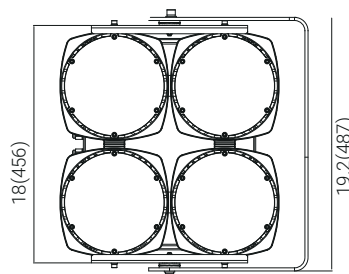

560W

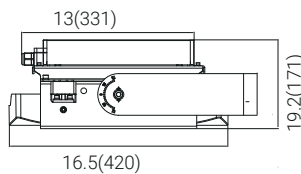
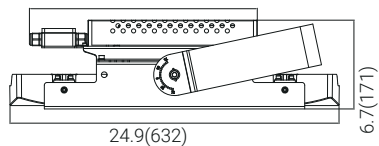

YOKE

unit: in(mm)

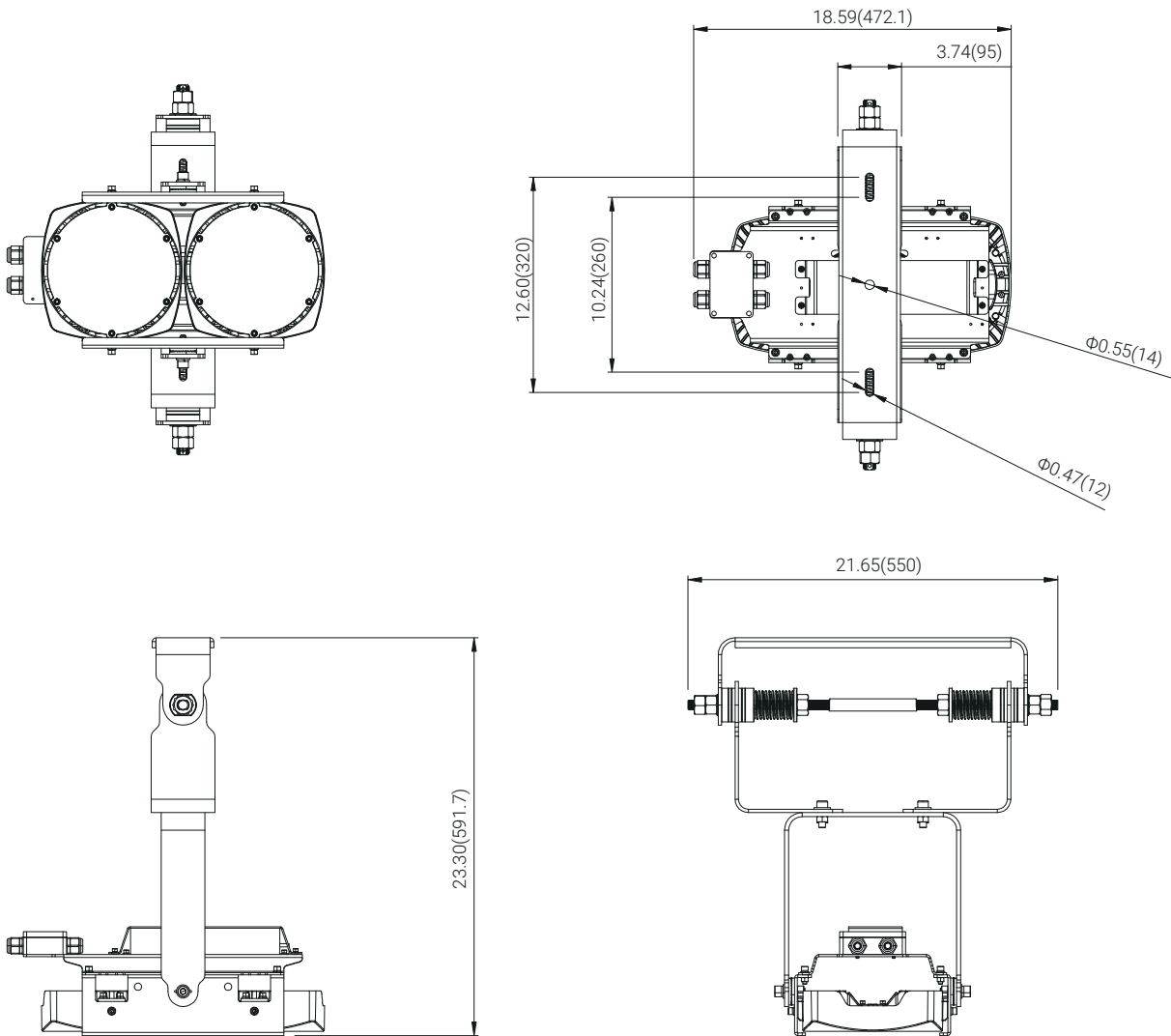

YOKE with Damper Bracket

HAZARDOUS LOCATION LIGHTING BASICS

Atmosphere Groups

Temperature Classification

Substance	Hazard Class	Division Groups	Zone Groups	Max. Surface Temperatures	NEC® 500 CEC®	NEC® 500/IEC-Group II
Acetylene	Class I Flammable Gases	Group A	IIC	450°C(842°F)	T1	T1
Hydrogen		Group B	IIC	300°C(572°F)	T2	
Ethylene		Group C	IIB	280°C(536°F)	T2A	T2
Propane		Group D	IIA	260°C(500°F)	T2B	
Methane		Group D	IIA ²	230°C(446°F)	T2C	
Combustible Metal Dusts	Class II Combustible Dusts	Group E ¹	IIIC ³	215°C(419°F)	T2D	T3
Combustible Carbonaceous Dust		Group F	IIIB ³	200°C(392°F)	T3	
Combustible Dusts not in Group E or F (Flour, Grain, Wood, Plastics, Chemicals)		Group G	IIIB ³	180°C(256°F)	T3A	
Combustible Fibers and Flyings				Class III Fibers and Flyings	Not Applicable	
				160°C(320°F)	T3C	
				135°C(275°F)	T4	T4
				120°C(248°F)	T4A	
				100°C(212°F)	T5	T5
				85°C(185°F)	T6	T6

Note 1: Group E is applicable to Class II, Division 1 only.
 Note 2: Methane is a Group IIA Gas for non-mining applications.
 Note 3: Group IIIA, IIIB and IIIC have not been adopted by the Canadian Electrical Code.

Classification of Divisions and Zones

Hazard Level	Division Scheme	Zone Scheme	Definitions
Continuous Hazard	Division 1	Zone 0 / Zone 20	A place in which an explosive atmosphere is continually present
Intermittent Hazard		Zone 1 / Zone 21	A place in which an explosive atmosphere is likely to occur in normal operation
Hazard Under Abnormal Conditions	Division 2	Zone 2 / Zone 22	A place in which an explosive atmosphere is not likely to occur in normal operation, but may occur for short periods

IP Codes

1st No.	Solid Objects
0	No protection
1	Objects greater than 50mm
2	Objects greater than 12.5mm
3	Objects greater than 2.5mm
4	Objects greater than 1mm
5	Dust protected
6	Dust proof
2nd No.	Liquids
0	No protection
1	Vertically dripping
2	Dripping up to 15°
3	Limited spraying
4	Splashing from all directions
5	Hosing jets from all directions
6	Strong hosing jets from all directions
7	Temporary immersion
8	Continuous immersion
9	Steam-jet cleaning

IK Ratings

IK Code	Level of Protection Achieved
IK00	Not protected
IK01	Protected against 0.14 joules impact
IK02	Protected against 0.2 joules impact
IK03	Protected against 0.35 joules impact
IK04	Protected against 0.5 joules impact
IK05	Protected against 0.7 joules impact
IK06	Protected against 1 joules impact
IK07	Protected against 2 joules impact
IK08	Protected against 5 joules impact
IK09	Protected against 10 joules impact
IK10	Protected against 20 joules impact



1(262) 456-5002
contact@redskylighting.com
www.redskylighting.com

RED SKY LIGHTING LLC
9370 Pittsburgh Ave Rancho
Cucamonga, CA 91730, USA

Disclaimer

The product information provided is, to the best of Red Sky Lighting's knowledge, accurate as of the date of publication. However, purchasers and end-users of Red Sky Lighting's products should refer to the documentation available on www.redskylighting.com for the most up-to-date and controlling product specifications, installation manuals, sales terms and conditions, and warranty terms. To the extent any contract is formed for the sale of Red Sky Lighting's products, whether directly with Red Sky Lighting or through any third party, the versions of such documentation posted on www.redskylighting.com as of the date of sale shall govern and prevail over any inconsistent information that may be provided elsewhere. In the event of a conflict between the information contained in this document and that available on www.redskylighting.com, the website documentation shall control.